

**KENWOOD**

AUDIO/VIDEO STEREO RECEIVER  
**KR-V7040**

**INSTRUCTION MANUAL**

KENWOOD CORPORATION

# Introduction

Your choice of this product indicates that you are a devotee to excellence in sound reproduction.

We appreciate your patronage and take pride in the long tradition of quality components that our company represents.

So that you can get the most out of your unit, we suggest that you take the time to read through this manual before you hook up and operate your system. This will acquaint you with operating features and system-connection considerations so that your listening pleasure will be enhanced right from the start. You will notice that in all aspects of planning, engineering, styling, operating convenience and adaptability we have sought to anticipate your needs and desires.

**Keep this manual handy for future reference.**

## For your records

Record the serial number, found on the back of the unit, in the spaces designated on the warranty card, and in the space provided below. Refer to the model and serial numbers whenever you call upon your dealer for information or service on this product.

Model \_\_\_\_\_ Serial Number \_\_\_\_\_

## Unpacking

Unpack the unit carefully and make sure that all accessories are put aside so they will not be lost.

Examine the unit for any possibility of shipping damage. If your unit is damaged or fails to operate, notify your dealer immediately. If your unit was shipped to you directly, notify the shipping company without delay. Only the consignee (the person or company receiving the unit) can file a claim against the carrier for shipping damage.

We recommend that you retain the original carton and packing materials for use should you transport or ship the unit in the future.

## For the USA

### Note to CATV system installer:

This reminder is provided to call the CATV system installer's attention to Article 820-40 of the NEC that provides guidelines for proper grounding and, in particular, specifies that the cable ground shall be connected to the grounding system of the building, as close to the point of cable entry as practical.

## Accessories

FM indoor antenna ..... 1    AM loop antenna ..... 1

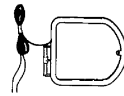
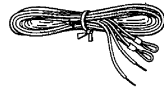

Antenna adaptor  
(75 Ω/300 Ω) ..... 1  
(Except for some areas)

Loop antenna holder ..... 1



Batteries  
(R6 or AA) ..... 2

Remote control unit ..... 1

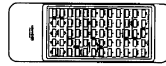
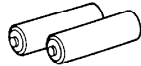

AC plug adaptor ..... 1  
(except for some areas)



For the unit with a European  
AC plug in areas other than  
Europe.

## Contents

**Caution: Read the pages marked ⚠ carefully to ensure safe operation.**

Introduction .....	2	Operation of remote control unit .....	12
⚠ Before applying power .....	3	Basic operation .....	14
⚠ Safety precautions .....	3	Listening to broadcasts .....	18
⚠ IMPORTANT SAFEGUARDS .....	4	Operation with video components .....	22
System connections .....	6	DOLBY 3 STEREO .....	23
FM DE-EMPHASIS/CHANNEL SPACE switch .....	9	DOLBY SURROUND .....	24
System control operation .....	10	In case of difficulty .....	28
Controls and indicators .....	11	⚠ Specifications .....	30

**⚠ Caution: Read this page carefully to ensure safe operation.**

## Before applying power

### For the U.S.A. and Canada

#### Important!

Units shipped to the U.S.A. and Canada are designed for operation on 120 volts AC only.

**CAUTION:** TO PREVENT ELECTRIC SHOCK DO NOT USE THE AC PLUG WITH AN EXTENSION CORD, RECEPTACLE OR OTHER OUTLET UNLESS THE BLADES CAN BE FULLY INSERTED TO PREVENT BLADE EXPOSURE.

### For the United Kingdom

#### Important!

Units shipped to the U.K. are designed for operation on 240 volts AC only.

The mains plug must be removed from the wall socket prior to any internal examination.

The wires in this mains lead are coloured in accordance with the following code:

Blue ..... Neutral  
Brown ..... Live

The wires in this mains lead must be connected to the terminals in the plug as follows:

Wire colour	Plug terminal marking
Blue .....	N or Black
Brown .....	L or Red

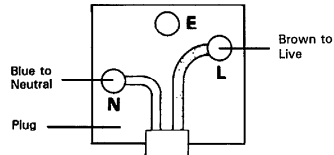

#### Notes:

1. If a 13-amp plug is used, this must be fitted with a 5-amp fuse.
2. If a 3-pin plug with earthing contact is used, no wire must be connected to the E terminal.

### For Australia and Europe

#### Important!

Units shipped to Australia are designed for operation on 240 V AC only.

Units shipped to Europe are designed for operation on 230 V AC only.

### For other countries

#### Important!

Units shipped to countries other than the above countries are equipped with an AC voltage selector switch on the rear panel. Refer to the following paragraph for the proper setting of this switch.

#### AC voltage selection

This unit operates on 110-120 or 220-240 volts AC. The AC voltage selector switch Type A or Type B on the rear panel is set to the voltage that prevails in the area to which the unit is shipped. Before connecting the power cord to your AC outlet, make sure that the setting position of this switch matches your line voltage. If not, it must be set to your voltage in accordance with the following direction.

#### Note:

Our warranty does not cover damage caused by excessive line voltage due to improper setting of the AC voltage selector switch.

#### AC voltage selector switch

##### Type A

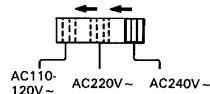



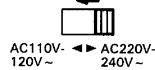

##### Type B



Move switch lever to match your line voltage with a small screwdriver or other pointed tool.

## Safety precautions

**WARNING:** TO PREVENT FIRE OR ELECTRIC SHOCK, DO NOT EXPOSE THIS APPLIANCE TO RAIN OR MOISTURE.

 <p><b>CAUTION</b> DO NOT REMOVE THE COVER OR THE SERVICE PARTS.</p> 	<p>CAUTION: TO REDUCE THE RISK OF ELECTRIC SHOCK, DO NOT REMOVE COVER (OR BACK). NO USER-SERVICEABLE PARTS INSIDE, REFER SERVICING TO QUALIFIED SERVICE PERSONNEL.</p>
	<p>THE LIGHTNING FLASH WITH ARROWHEAD SYMBOL, WITHIN AN EQUILATERAL TRIANGLE, IS INTENDED TO ALERT THE USER TO THE PRESENCE OF UNINSULATED "DANGEROUS VOLTAGE" WITHIN THE PRODUCT'S ENCLOSURE THAT MAY BE OF SUFFICIENT MAGNITUDE TO CONSTITUTE A RISK OF ELECTRIC SHOCK TO PERSONS.</p>
	<p>THE EXCLAMATION POINT WITHIN AN EQUILATERAL TRIANGLE IS INTENDED TO ALERT THE USER TO THE PRESENCE OF IMPORTANT OPERATING AND MAINTENANCE (SERVICING) INSTRUCTIONS IN THE LITERATURE ACCOMPANYING THE APPLIANCE.</p>

## IMPORTANT SAFEGUARDS

**Caution :** Read this page carefully to ensure safe operation.

Please read all of the safety and operating instructions before operating this unit. For best results, follow all warnings placed on the unit and adhere to the operating and use instructions. These safety and operating instructions should be retained for future reference.

**1. Power sources** — The unit should be connected to a power supply only of the type described in the operating instructions or as marked on the appliance.

**2. Power-cord protection** — Power-supply cords should be routed so that they are not likely to be walked on or pinched by items placed upon or against them, pay particular attention to cords at plugs, convenience receptacles, and the point where they exit from the unit.

Never pull or stretch the cord.

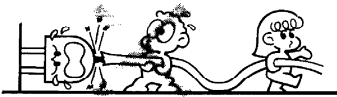

**3. Grounding or polarization** — The precautions should be taken so that the grounding or polarization means of this unit is not defeated.

**4. Ventilation** — The unit should be situated so that its location or position does not interfere with its proper ventilation.

To maintain good ventilation, do not put records or a table-cloth on the unit. Place the unit at least 10 cm away from the walls.

Do not use the unit on a bed, sofa, rug or similar surface that may block the ventilation openings.

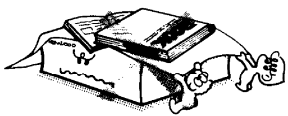

**5. Water and moisture** — The unit should not be used near water — for example, near a bathtub, washbowl, kitchen sink, laundry tub, in a wet basement, or near a swimming pool, etc.

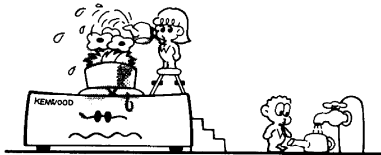

**6. Temperature** — The unit may not function properly if used at extremely low, or freezing temperatures. The ideal ambient temperature is above +5°C (41°F).

**7. Heat** — The unit should be situated away from heat sources such as radiators, heat registers, stoves, or other units (including amplifiers) that produce heat.

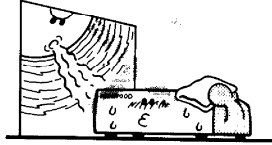

**8. Electric shock** — Care should be taken so that objects do not fall and liquid is not spilled into the enclosure through openings. If a metal object, such as a hair pin or a needle, comes into contact with the inside of this unit, a dangerous electric shock may result. For families with children, never permit children to put anything, especially metal, inside this unit.

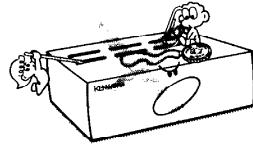

**9. Enclosure removal** — Never remove the enclosure. If the internal parts are touched accidentally, a serious electric shock might occur.

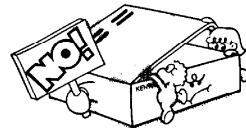

**10. Magnetic fields** — Keep the unit away from sources of magnetic fields such as TV sets, speaker systems, radios, motorized toys or magnetized objects.

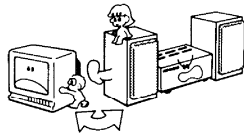

**11. Cleaning** — Do not use volatile solvents such as alcohol, paint thinner, gasoline, or benzine, etc. to clean the cabinet. Use a clean dry cloth.

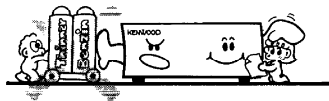

**⚠ Caution : Read this page carefully to ensure safe operation.**

**12. Carts and stands** — An appliance and cart combination should be moved with care. Quick stops, excessive force, and uneven surfaces may cause the appliance and cart combination to overturn.



**13. Nonuse periods** — The power cord of the unit should be unplugged from the outlet when left unused for a long period of time.

**14. Abnormal smell** — If an abnormal smell or smoke is detected, immediately turn the power OFF and pull out the power cord. Contact your dealer or nearest service center.

### POWER OFF!



**15. Damage requiring service** — The unit should be serviced by qualified service personnel when:

- A. The power-supply cord or the plug has been damaged; or
- B. Objects have fallen, or liquid has been spilled into the unit; or
- C. The unit has been exposed to rain; or
- D. The unit does not appear to operate normally or exhibits a marked change in performance; or
- E. The unit has been dropped, or the enclosure damaged.

**16. Servicing** — The user should not attempt to service the unit beyond that described in the operating instructions. All other servicing should be referred to qualified service personnel.

**17. Outdoor antenna grounding** — If an outside antenna is connected to the receiver, be sure the antenna system is grounded so as to provide some protection against voltage surges and built up static charges. Section 810 of the National Electrical Code, ANSI/NFPA 70, provides information with respect to proper grounding of the mast and supporting structure, grounding of the lead-in wire to an antenna discharge unit, size of grounding con-

ductors, location of antenna-discharge unit, connection to grounding electrodes, and requirements for the grounding electrode. See Figure.

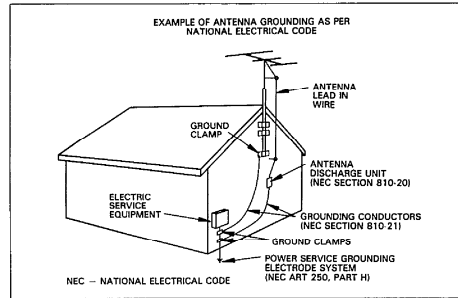

**18. Power lines** — An outdoor antenna should be located away from power lines.

**19. AC outlets** — Do not connect other audio equipment with a power consumption larger than that specified to the AC outlet on the rear panel. Never connect other electrical units, such as an iron or toaster, to it to prevent fire or electric shock.

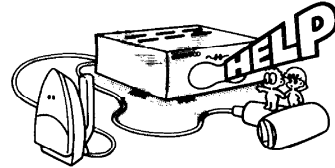

**Notes:**

- 1. Item 3 is not required except for grounded or polarized equipment.
- 2. Item 17 and 18 are not required except for units provided with antenna terminals.
- 3. Item 17 complies with UL in the U.S.A.

# System connections

Make connections as shown in the diagram below. When connecting the related system components, refer also to the instruction manuals of the related components.  
Do not plug in the power lead until all connections are completed.

## ■ Connection of audio components

For the connection of video components, please refer to page 22.

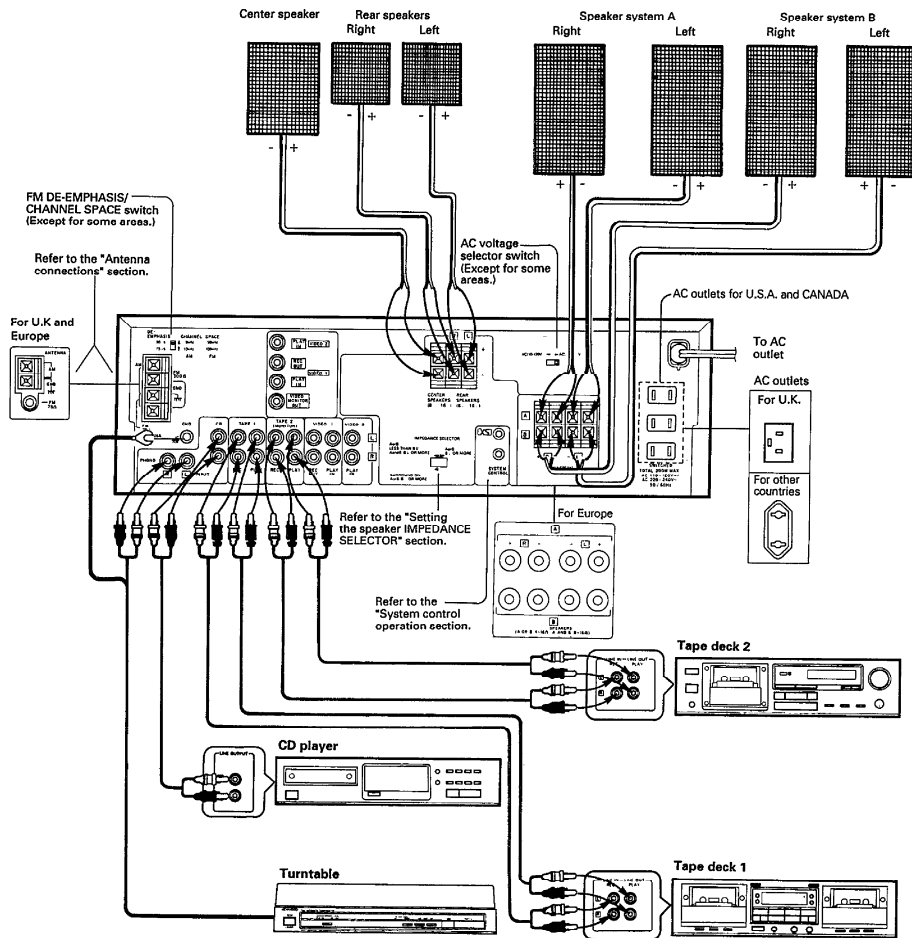

### Notes:

1. Connect all cords firmly. If connections are loose there could be loss of sound or noise produced.
2. Do not connect up a power source which is larger than that indicated on the socket at the rear of the unit.
3. When plugging and unplugging connection cords, be sure to first remove the power cord from the AC outlet. Plugging/unplugging connection cords without removal of the power cord can cause malfunctions or damage to the unit.

## Connection of speakers

### Speaker terminals for general

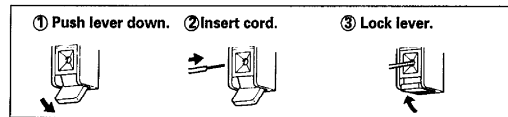

### Front speaker terminals for Europe

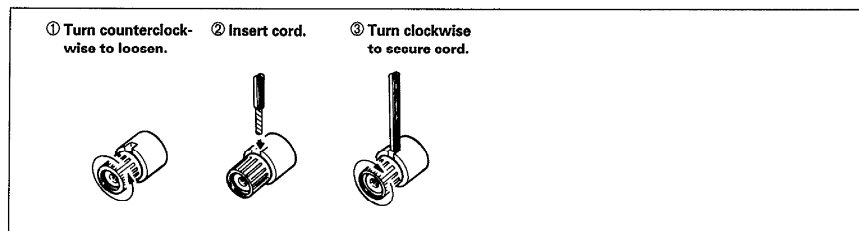

- Never short-circuit the + and - speaker cords.
- If the left and right speakers are connected inversely or if the speaker cords are connected with reversed polarity, the sound becomes unnatural with ambiguous acoustic image positioning. Be sure to connect the speakers and speaker cords correctly.

## Setting the SPEAKER IMPEDANCE SELECTOR

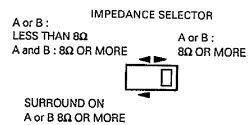

According to the impedance of the speakers used, set the SPEAKER IMPEDANCE SELECTOR on the rear panel as shown in the table.

- During speaker system connection and operation of the SPEAKER IMPEDANCE SELECTOR, set the POWER switch to OFF.
- When the IMPEDANCE SELECTOR is in  position, sound is not output from the center and rear speakers.

### ① When Surround speakers are not connected

Usable speaker impedance	Selector position
<b>When speakers A and B are connected</b>  The impedance of both speakers should be 8Ω - 16Ω.	
<b>When speakers A or B are connected</b>  When the impedance of the speakers is 8Ω - 16Ω  When the impedance of the speakers is 4Ω - 6Ω	

### ② When Surround speakers are connected

Usable speaker impedance	Selector position
The impedance of the front speakers A and B, center speaker and rear speakers should be 8Ω - 16Ω.	
When both of SPEAKERS A and B keys are ON, pressing the PRO LOGIC key or 3 STEREO key switches the speakers key setting to A ON alone. If the B key is pressed now, the SPEAKERS key setting will be switched to B ON alone.	

## System connections

### Connection of antennas

- ① Push the lever.
- ② Insert the conductor.
- ③ Return the lever.

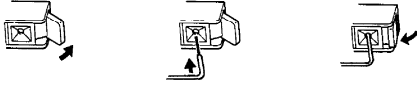

### ■ AM loop antenna connection

The supplied antenna is for indoor use. Place it as far as possible from the main system, TV set, speaker cords and power cord, and set it to a direction which provides the best reception.



### ■ AM outdoor antenna connection

If the reception is poor when the AM loop antenna is used, distribute a vinyl-coated wire of more than 6 meters outdoors, without disconnecting the loop antenna.

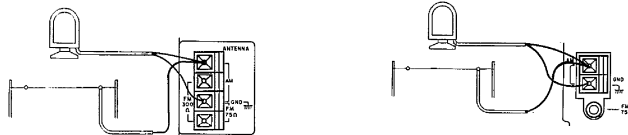

### ■ FM indoor antenna connection

The supplied antenna is for indoor use. For stable reception, remove the indoor antenna after installing an outdoor antenna as soon as possible.

- ① Find the position that provides best reception.
- ② Fix two ends.



### ■ FM outdoor antenna connection

It is recommended to install an exclusive FM outdoor antenna to capture FM broadcasts with high sound quality. Use a coaxial cable for the connection between the outdoor antenna and FM ANTENNA terminal on the rear panel.

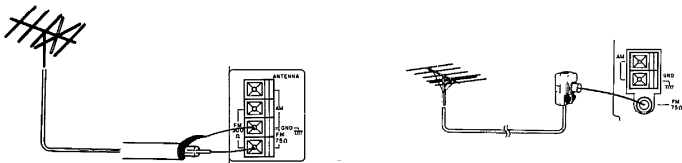

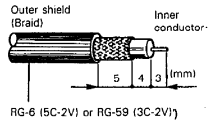
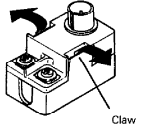
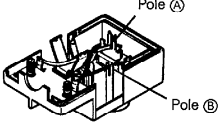
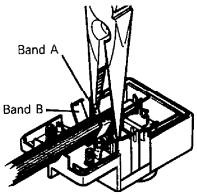
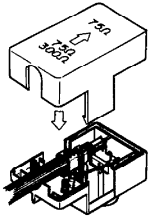
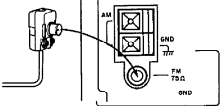

## ■ 75Ω coaxial cable connection (For U.K. and Europe)

<p>① Arrange the coaxial cable as illustrated.</p>  <p>Outer shield (Braid) Inner conductor 5 4 0 (mm) RG-6 (5C-2V) or RG-59 (3C-2V)</p>	<p>② Open the antenna adaptor. Open the claws with the fingers to release the lock and pull out the cover.</p>  <p>Claw</p>	<p>③ Remove the inner conductor from the groove of pole ㉑ and insert it in the groove of pole ㉒.</p>  <p>Pole ㉑ Pole ㉒</p>
<p>④ Insert into the slit on the clip. Fasten the bands A and B, using a pair of pliers.</p>  <p>Band A Band B</p>	<p>⑤ Close the cover.</p> 	<p>⑥ Connect the adaptor to the antenna terminal.</p> 

## FM DE-EMPHASIS/CHANNEL SPACE switch (Except for some areas)

The FM DE-EMPHASIS/CHANNEL SPACE switch on the rear panel is set to the correct setting that prevails in the area to which the unit is shipped. However, if the FM DE-EMPHASIS/CHANNEL SPACE setting is not matched to the area where the unit is to be used; for instance, when you move from area 1 to area 2 or vice versa, desired reception of AM/FM broadcasts is not expected. In this case, change the FM DE-EMPHASIS/CHANNEL SPACE setting in accordance with the area corresponding to the table. The FM DE-EMPHASIS is switched over at the same time.

Area	CHANNEL SPACE freq.	FM DE-EMPHASIS
1 U.S.A., Canada, and South American countries.	FM : 100 kHz AM : 10 kHz	75 μs
2 Other countries	FM : 50 kHz AM : 9 kHz	50 μs

- When changing the setting of the FM DE-EMPHASIS/CHANNEL SPACE switch, first disconnect the power cord, then reset the channel space switch, connect the power cord again during pressing the TUNER key of the input selector, and turn the power on.
- When activating the CHANNEL SPACE switch, the preset memory contents of the tuner and the set up memory contents of the SURROUND function will be lost.

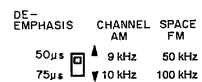

# System control operation

## Connection

Using the system control cords provided with KENWOOD system component models, make connections as shown below.

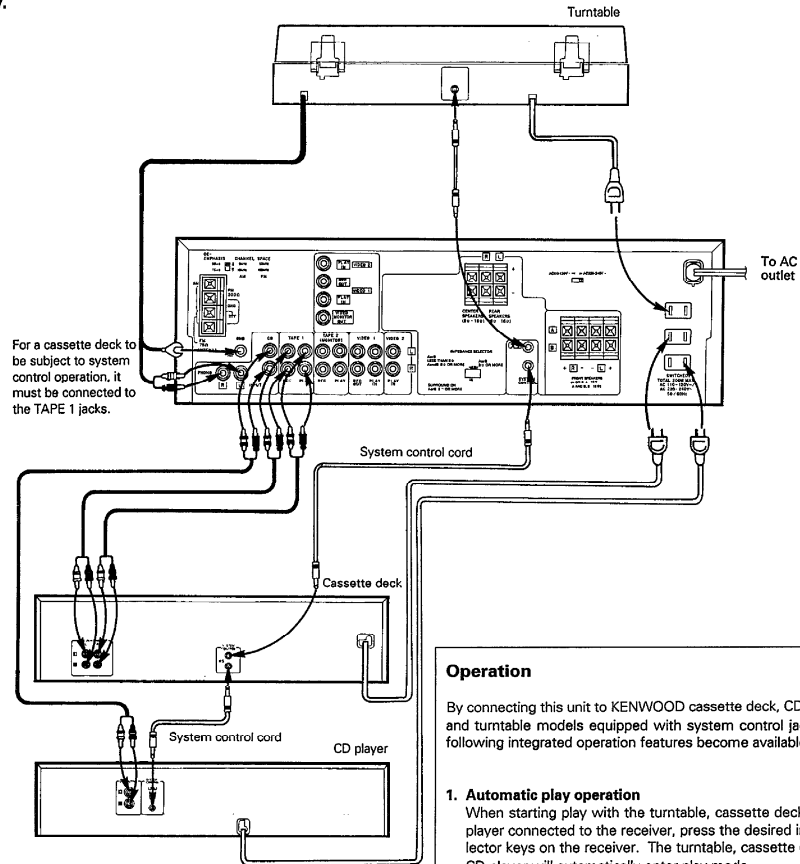

### System control connection

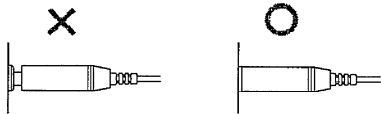

- Be sure to insert the system control cord plugs fully into the SYSTEM CONTROL terminals.
- If the system control cord and audio cords are not connected properly, the automatic system governing remote control and system functions will not operate.

### Operation

By connecting this unit to KENWOOD cassette deck, CD player, and turntable models equipped with system control jacks, the following integrated operation features become available.

#### 1. Automatic play operation

When starting play with the turntable, cassette deck, or CD player connected to the receiver, press the desired input selector keys on the receiver. The turntable, cassette deck, or CD player will automatically enter play mode.

In the same way, pressing the play key of turntable, cassette deck, or CD player will automatically switch the input selector on the receiver to the component on which the Play key is pressed.

#### 2. Synchro recording

To record the sound from the CD player or turntable on a tape with the cassette deck, press the CD or PHONO of the input selector keys and load a CD or record. Set the cassette deck to rec pause mode, then press the PLAY (START) key of the CD player or turntable. The cassette deck will start recording automatically, synchronized with the CD player or turntable starting play.

#### 3. Remote control

The remote control unit provided with this unit, to which a KENWOOD system turntable, cassette deck, or CD player is connected, is equipped with related control keys. The related components can be controlled used these keys.

# Controls and indicators

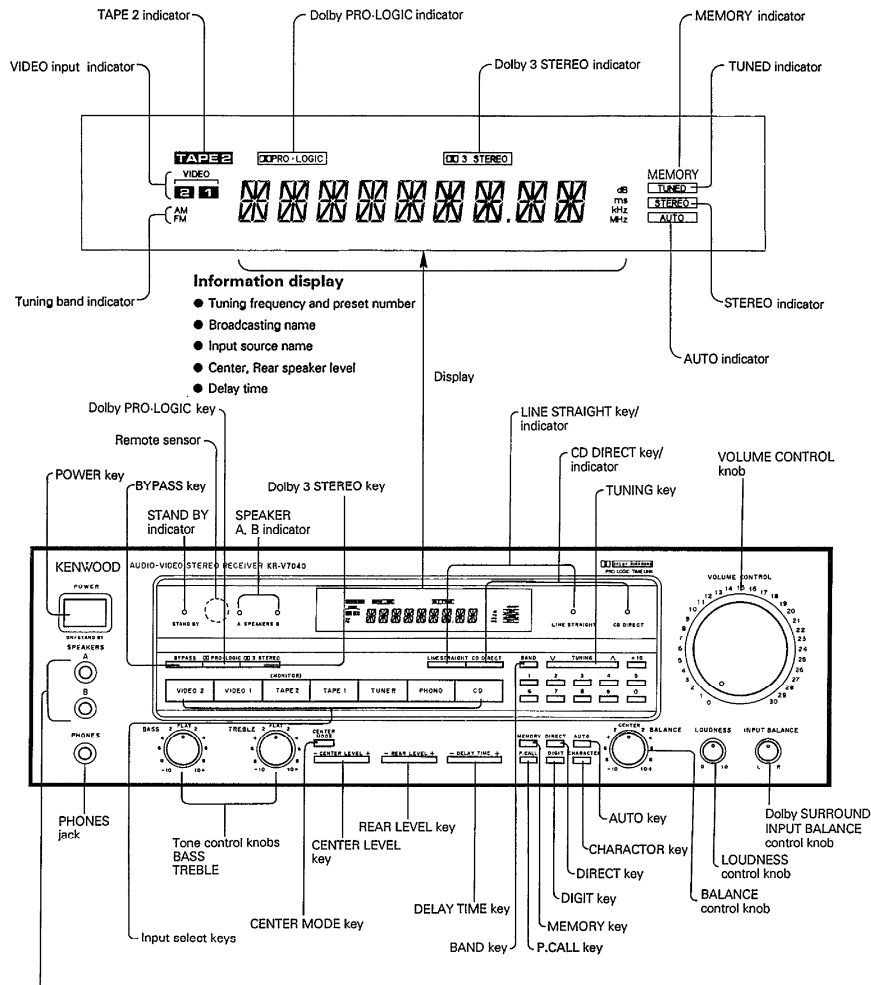

## SPEAKER A and B keys

- A, B OFF** ● This position silences all speakers to permit private use of headphones.
- A ON** ● Activates speakers connected to the SPEAKERS A terminals on the rear panel.
- B ON** ● Activates the speakers connected to the SPEAKERS B terminals on the rear panel.
- A, B ON** ● Activates the speakers connected to the SPEAKERS A and B terminals simultaneously.

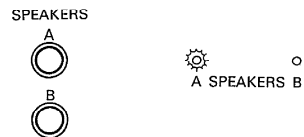

- When both of SPEAKERS A and B keys are ON, pressing the PRO LOGIC key or 3 STEREO key switches the SPEAKERS key setting to A ON alone. If the B key is pressed now, the SPEAKERS key setting will be switched to B ON alone.

## Operation of remote control unit

In addition to the remote control of the receiver unit, the provided remote control unit can control a KENWOOD cassette tape deck, CD player, turntable, graphic equalizer, etc., connected via the KENWOOD system control cords.

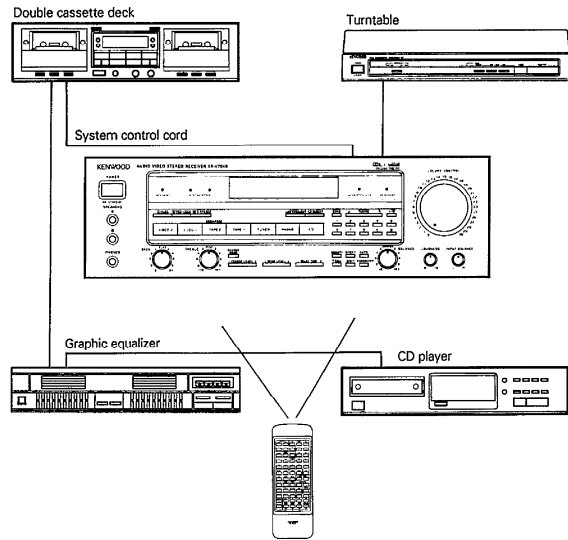

### ■ Loading batteries

#### 1 Remove the cover.

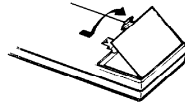

#### 2 Insert batteries.

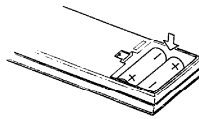

Insert two AA-size (RG/SUM-3) batteries as indicated by the polarity marking.

#### 3 Close the cover.

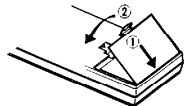

### ■ Operation procedure

Plug the power cord of the system into an AC wall outlet, and press the [POWER] key on the remote control unit to turn the power on.

When the power is turned on, press the key of the source component to be operated.

- When two operation keys on the remote control unit are pressed successively, press each key securely reserving an interval of more than 1 second for each press.
- Be sure to read the instruction manuals of the components connected via the system control cords.

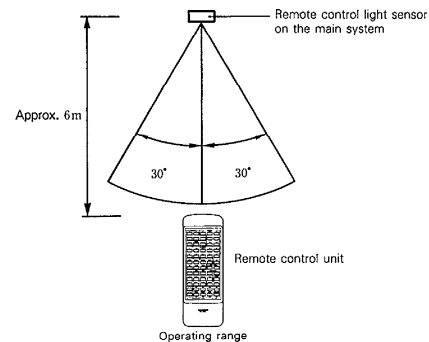

#### Notes:

1. The supplied batteries are intended for use in operation checks. Therefore, their lives may be shorter than ordinary batteries.
2. When the remote-controllable distance becomes gradually shorter, replace both batteries with new ones.
3. Malfunction may occur if direct sunlight or the light of a high-frequency light (fluorescent lamp) enters the remote control light sensor. In such a case, change the system installation position to prevent malfunction.

### TUNER operation keys

**BAND:** Switches the bands.  
**P. CALL:** Recalls the preset stations.  
**DIRECT:** In conjunction with the numeric keys, tunes stations directly.

### Tape deck operation keys

Two sets of operation keys, the TAPE A and TAPE B keys, allow to operate a double-deck type cassette tape deck. Use the TAPE B keys if your cassette tape deck is of the single-deck type.

### CD player operation keys

Operate the CD player.  
**DISC:** The DISC key can be used as the disc selector key of a multi-disc player with a disc changer.  
For details, read the instruction manual provided with the CD player.

### Numeric keys

When the CD source is selected, these keys can be used as the numeric keys of the CD player.

When the TUNER source is selected, they can be used as the numeric keys of the tuner.

How to enter numerals:

For 23 press **+10** twice and **3**

For 40 press **+10** four times and **0**

### Surround operation keys

The functions of the keys marked  in the following illustration can be operated from the remote control unit only. Read page 26 for details.

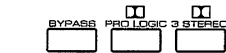

### Input selector keys

Switches the input selector on the amplifier.

### MUTE key

Press to reduce the volume temporarily. During operation, the indicator on the VOLUME CONTROL knob blinks.

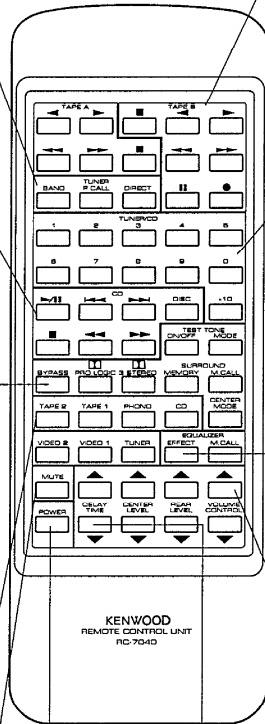

### Graphic equalizer operation keys

**M.CALL:** Every time the key is pressed, the equalizer patterns are recalled from memory.

**EFFECT:** This key turns the graphic equalizer effect ON/OFF.

### VOLUME CONTROL keys

Adjust the volume. During operation, the VOLUME CONTROL knob on the front panel turns and the indicator on the knob blinks at high speed.

### Surround level control keys

CENTER LEVEL  
REAR LEVEL  
DELAY TIME

### POWER key

Press to switch the power ON/OFF.

# Basic operation

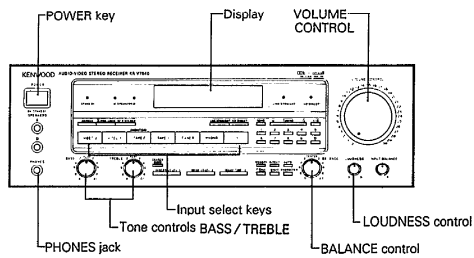

## Basic operation

**1 Press the POWER key to ON.**

**2 Select an input source.**

The source name characters appear on the display.

**3 Play the source component.**

**4 Adjust the volume.**

Main unit

Remote control unit

- When the volume is adjusted from the remote control unit, the VOLUME CONTROL knob on the main unit rotates while the point indicator is blinking.

**5 Adjust the left and right volume balance.**

**6 Adjust the tone.**

BASS 2 FLAT 2

TREBLE 2 FLAT 2

## ■ To mute the sound temporarily

### REMOTE CONTROL ONLY

Press the MUTE key on the remote control unit.

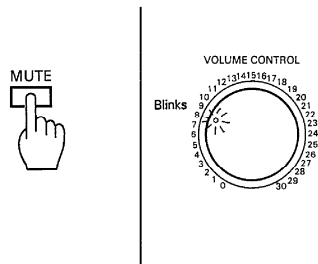

- The indicator on the VOLUME CONTROL knob on the front panel blinks.
- Pressing the key again resumes the previous volume.

## ■ Listening through headphones

### 1 Insert the headphone plug into the headphones jack.

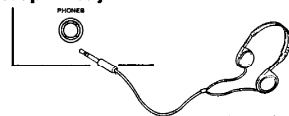

- Set the SPEAKERS switch so that both speaker systems A and B are OFF.

### 2 Adjust the volume.

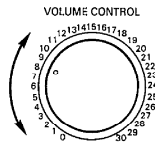

- Be sure to minimize the volume before unplugging the headphone plug.

### Note on LOUDNESS control

Listening at high volume allows to enjoy dynamic sound, but human ears tend to feel low frequencies insufficient when listening at low volume. When the VOLUME CONTROL is set to a low position, the insufficiency of low frequencies felt by human ears can be compensated by turning the LOUDNESS control clockwise.

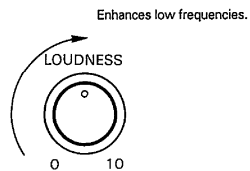

- The effect of LOUDNESS control is less sensible if the VOLUME CONTROL is set to the '5' position or above.

### Notes:

1. When the TAPE 2 key is set to ON, the source selected with the INPUT SELECTOR cannot be heard from the speakers. To listen to a source other than cassette deck 2, be sure to set the TAPE 2 key to OFF.
2. The source selected with the INPUT SELECTOR is backed up for a few days even when the power cord is unplugged. After this period, the tuner is automatically selected when the power is supplied.

### STAND BY mode of POWER switch

When the power cord of this system is plugged into an AC outlet, the STAND BY indicator lights up regardless of the ON/OFF setting of the POWER switch. This indicates that a small amount of current is being supplied to the unit to back up the memory contents. This mode is referred to as the Stand By mode. While the STAND BY indicator is lit, the power of the system can be switched ON/OFF from the remote control unit.

## Basic operation

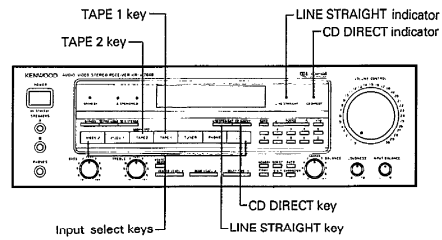

### ■ Operation of CD DIRECT playback

The digital sound of Compact Disc features an ideal reproduction characteristics, and the sound quality provided by CD can be reproduced with least degradation by means of the CD direct playback function.

### ■ Operation of LINE STRAIGHT playback

This CD, with least degradation of sound quality.

**1 Press the CD DIRECT key.**

Lights up.

LINE STRAIGHT CD DIRECT

---

**2 Play the CD player.**

PLAY/PAUSE

- The CD DIRECT selection is given priority to any other source being selected by the INPUT SELECTOR.

**1 Select an input source.**

---

**2 Press the LINE STRAIGHT key.**

LINE STRAIGHT CD DIRECT

---

**3 Play the input source.**

**To cancel the CD DIRECT playback function.**

Press the CD DIRECT key again, or select the INPUT SELECTOR.

CD DIRECT

- CD DIRECT indicator goes off.

**To cancel LINE STRAIGHT playback function.**

Press the LINE STRAIGHT key again.

LINE STRAIGHT

- CD DIRECT indicator goes off.

Note:  
During CD DIRECT or LINE STRAIGHT playback, the tone controls do not function.



## ■ Ordinary tape recording

**1 Select the source to be recorded.**

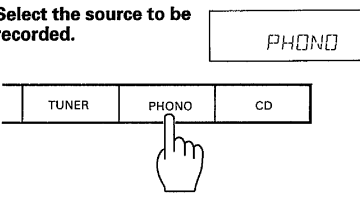

**2 Set cassette deck 1 or 2 in the record-pause mode.**

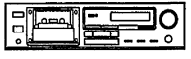

**3 Play the source component to be recorded, and start recording it on the cassette deck.**

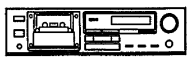

- In case of tape dubbing (TAPE 1 → TAPE 2), play the cassette deck connected to TAPE 1 and record on the cassette deck connected to TAPE 2.

## ■ Tape dubbing (TAPE2 → TAPE1)

**1 Press the TAPE 2 key.**

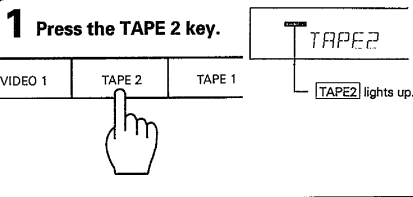

**2 Select a source other than TAPE 1.**

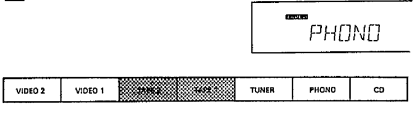

**3 Play cassette deck 2 and start recording on cassette deck 1.**

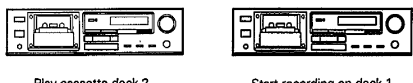

- Do not select TAPE 1 while dubbing.

Note:  
For the tape-to-tape dubbing procedure using a double-deck type cassette tape deck, please read the instruction manual provided with the double-deck type cassette tape deck.

## ■ Listening to CD while recording another source

**1 Select the source to be recorded.**

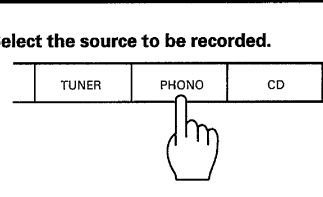

**2 Play the source to be recorded.**

**3 Start recording on the cassette deck connected to the TAPE 1 jacks.**



**4 Press the CD DIRECT key.**

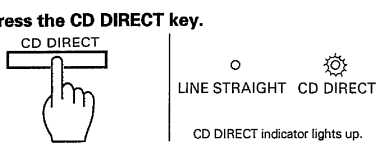

**5 Play the CD player.**

- No other source can be selected until the cassette deck recording is stopped.
- The source name on the display remains the same, i.e. the name of the recorded source.

# Listening to broadcasts

## ■ Receiving broadcast stations and storing them in memory (preset operation)

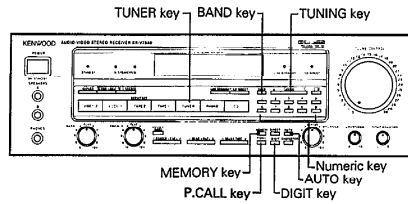

**1 Press the TUNER key.**

● Previous reception mode is resumed.  
● Pressing the BAND key also set the unit to tuner mode.

TUNER key: TAPE 1 | TUNER | PHONO

95.00

---

**2 Select the broadcast band.**

BAND key

95.00

Each time the BAND key is pressed, reception band changes between FM and AM.

---

**3 Select the tuning mode.**

AUTO key

AUTO lights up.

95.00

● Normally, select the auto mode (with AUTO lighted).  
Press the key to select the auto (AUTO lighted) or manual (not lighted) mode.

---

**4 Tune the desired station.**

To decrease frequency: V TUNING ^ To increase frequency

● The TUNED indicator lights up when a station is received.  
● Use manual tuning mode when the radio wave is weak and noisy. At this time, the stereo FM broadcast is received in monaural mode.

Auto tuning mode	Manual tuning mode
Press once. (Tuning stops automatically when a station is received.)	Press repeatedly, or press and hold, until the desired station is received.

---

**5 Store the station in preset memory.**

① Press the MEMORY key.

● Proceed the steps 2 while the MEMORY indicator is lighted.

MEMORY key

MEMORY lights up for approx. 5 sec.

98.50

② Press the numeric key.

Ex.) To select preset No. 3: [3]  
To select preset No. 13: [+10] [3]  
To select preset No. 20: [+10] [+10] [0]

BAND V TUNING ^ +10

1 2 3 4 5  
6 7 8 9 0

MEMORY goes off.

13 98.50

When preset No. 13 is selected.

● Up to 20 stations can be preset at random, regardless of the reception band.  
● When a station has previously been preset under the numeric key pressed, the newly preset station replaces the previous station.

## ■ Receiving a preset station

### Select the desired station.

Ex.) To select preset No. 3:   
 To select preset No. 13:  →   
 To select preset No. 20:  →  →

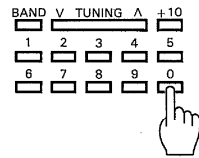

● The frequency of the station received will be displayed.

## ■ Listening to all preset stations in sequence (PRESET CALL)

Press the P. CALL key.



● Preset stations are received in order of 1 → 2 → 3 ... 10 ... 20 every time the key is pressed.

## ■ Direct tuning of radio stations

If you know the frequency of the desired station, it can be received directly by inputting the frequency using the numeric keys.

### 1 Select the broadcast band.

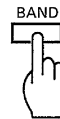

Each time the BAND key is pressed, reception band changes between FM and AM.

### 2 Press the DIRECT key.

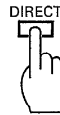

### 3 Input the frequency of the desired station by pressing the numeric keys.

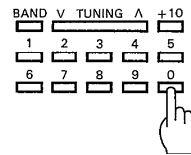

#### Example of input

Desired station	Order of pressing numeric keys
FM 90 MHz	<input type="text" value="9"/> <input type="text" value="0"/> <input type="text" value="0"/> (100 kHz space)
	<input type="text" value="9"/> <input type="text" value="0"/> <input type="text" value="0"/> <input type="text" value="0"/> (50 kHz space)
FM 102.5 MHz	<input type="text" value="1"/> <input type="text" value="0"/> <input type="text" value="2"/> <input type="text" value="5"/> (100 kHz space)
	<input type="text" value="1"/> <input type="text" value="0"/> <input type="text" value="2"/> <input type="text" value="5"/> <input type="text" value="0"/> (50 kHz space)
AM 810 kHz	<input type="text" value="8"/> <input type="text" value="1"/> <input type="text" value="0"/>
AM 1260 kHz	<input type="text" value="1"/> <input type="text" value="2"/> <input type="text" value="6"/> <input type="text" value="0"/>

#### Last channel memory

When the tuner's band selector is switched or when the input selector is switched from another source to TUNER, the last received station is recalled for each of FM, AM when the receiver power is switched ON.

## ■ Displaying station names

Station names composed of up to four digits of characters and/or symbols can be displayed on the tuner display.  
 Example: To receive FM 98.80 MHz, input its name with characters "CBE", and preset them under numeric key **3**.

### 1 Receive FM 98.80 MHz, and enter the character input mode.

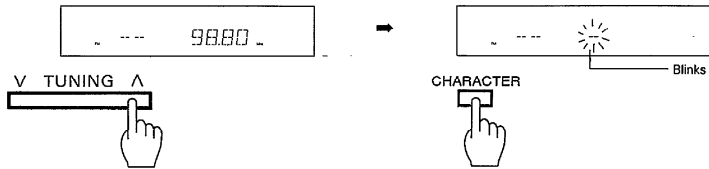

### 2 Select the characters to be displayed with that station.

① Display the desired character.

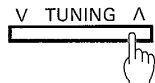

② Establish the selection.

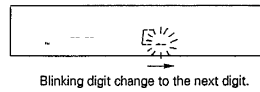

③ Repeat steps 1 and 2 until all of the required characters have been input.

- To select "C", press the UP segment three times.
- To insert a space, simply press the DIGIT key.

#### Types of characters that can be input

After having pressed the CHARACTER key, press the TUNING key to display the characters available.

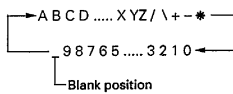

### 3 End the character input.

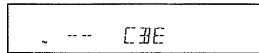

- The character input also terminates automatically when fourth character has been input.
- Press the CHARACTER key to terminate character input with three characters or less.

### 4 Preset them under key **3**.

① Press the MEMORY key.

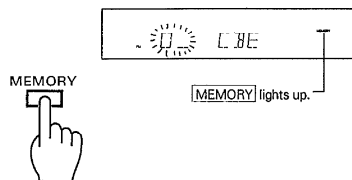

② Press numeric key **3**.

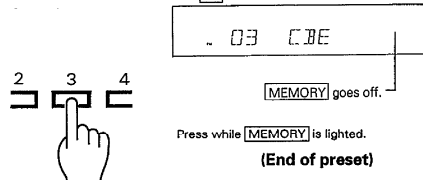

## ■ Changing a station name

Example: To change station name "FHN8" preset with AM (MW) 810 kHz frequency under key [2] to "FEN".

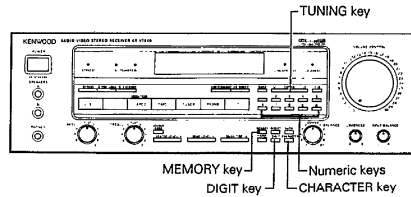

**1** Receive preset station of [2] by preset tuning, and enter the character input stand-by mode.

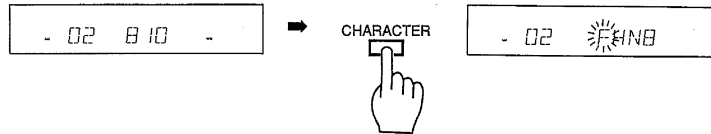

**2** Move the blinking digit to the second digit.

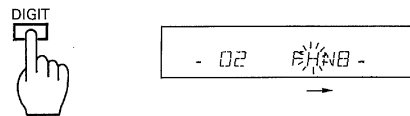

**3** Select "E" with the TUNING key.



**4** Move the blinking digit by two digits.

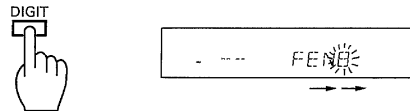

**5** Select the blank with the TUNING key.

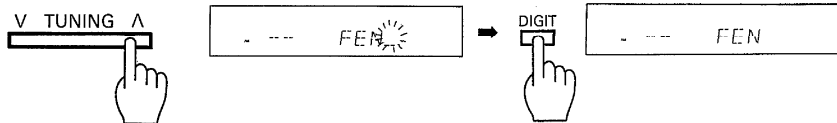

• The character input terminates automatically when fourth character has been input.

**6** Preset the new name under numeric key [2].

① Press the MEMORY key.

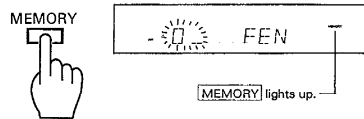

② Press numeric key [2].

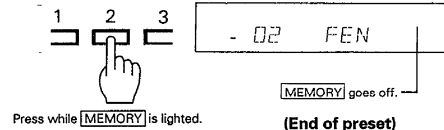

## Operation with video components

For the connections and operations, also read carefully the instruction manuals supplied with the video components to be connected.

When connect to the KENWOOD LD player having system control terminal, do not connect anything to the system control terminal of the LD player.

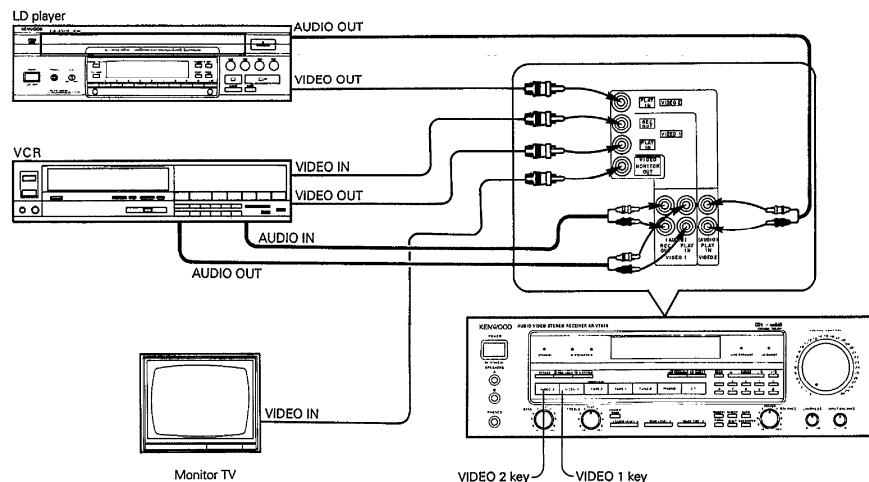

### ■ Playback of video tape

**1** Switch the power of the monitor TV ON.

**2** Press the VIDEO 1 key.

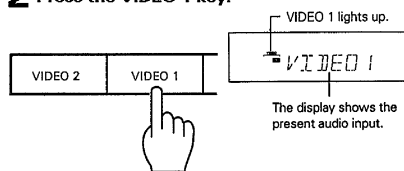

- When an input selector key other than VIDEO 1 is pressed, the audio input of the selected source will be played in place of the audio input from VIDEO 1.

**3** Play the VCR.

**4** Adjust the volume.

### ■ Recording of video source

**1** Connect the video source component to be recorded to the VIDEO 2 jacks.

- A video player deck, video camera, LD player, DBS tuner, etc., can be connected.

**2** Press the VIDEO 2 key.

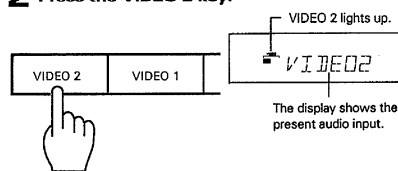

- When an input selector key other than VIDEO 2 is pressed, the audio input of the selected source will be played in place of the audio input from VIDEO 2.

**3** Play the video source component.

**4** Put the VCR in the record mode.

# DOLBY 3 STEREO

The Dolby 3 Stereo mode allows to enjoy "Dolby Surround" movies, etc., by combination of the front and center speaker sounds. The main effect of this mode is to provide a secure positioning of the center channel sound, such as words.

### Precaution

If the SPEAKER IMPEDANCE SELECTOR at the rear is set to "A or B 8 Ω OR MORE", the DOLBY SURROUND mode or DOLBY 3 STEREO mode cannot be obtained.

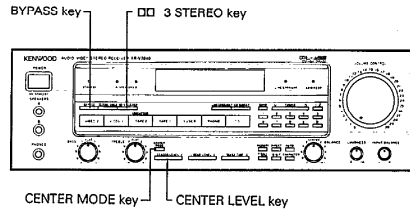

## ■ 3 STEREO balance adjustment

Remote control unit only

## ■ 3 STEREO playback

**1** Press the 3 STEREO key.

**2** Select the center mode.

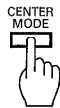

- The center mode is switched between NORMAL – WIDE every time the CENTER MODE key is pressed.
- Refer to step 2 on page 25 for proper selection of center mode.

**3** Generate the test tone.

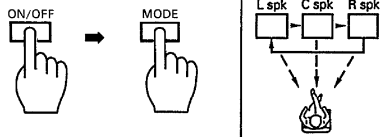

- The speaker generating the test tone is changed every time the MODE key is pressed.

**4** Adjust the center speaker volume.

Adjust the center speaker volume. Adjust so that the level of the center speaker is equal to that of the left and right speakers.

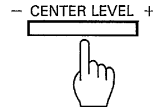

**5** Stop generating the test tone.

Press the TEST TONE ON/OFF key on the remote control unit.



**1** Press the 3 STEREO key.

**2** Select the center mode.



- The center mode is switched between NORMAL – WIDE every time the CENTER MODE key is pressed.

**3** Play a stereo software program or a Dolby surround program.

- The 3 STEREO can benefit non surround Programming too.

**4** Adjust the volume and tone.

To return to normal stereo playback from 3 STEREO.

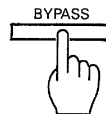

# DOLBY SURROUND

## Precaution

If the SPEAKER IMPEDANCE SELECTOR at the rear is set to "A or B 8 Ω OR MORE", the DOLBY SURROUND mode or DOLBY 3 STEREO mode cannot be obtained.

## Dolby Surround field adjustment

### Remote control unit only

First, set the sound balance for use in Dolby Surround playback by also using the remote control unit.

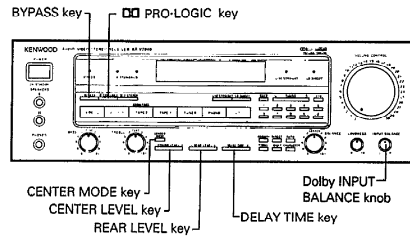

### 1 Switch Dolby Surround ON.

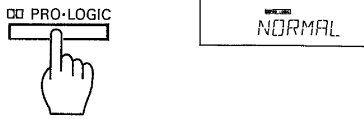

### 2 Select the center mode.



● Refer to step 2 on page 25 for proper selection of center mode.

### 3 Generate the test tone.

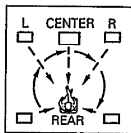

The speaker generating the noisy test tone is changed every time the MODE key is pressed.

#### In NORMAL or WIDE mode:

Test tone moves in the following order.

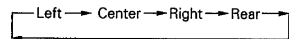

#### In PHANTOM or C-OFF mode:

Test tone moves in the following order.

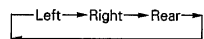

### 4 Adjust the volume balance.

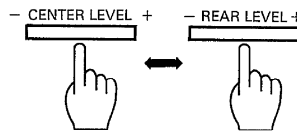

- Adjust so that the test tone volumes are the same on all speakers.
- The level being adjusted is displayed.

### 5 Turn the test tone OFF.



### 6 Set the delay time.

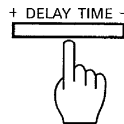

- Calculate the proper delay time for Dolby Surround by referring to the illustration below.

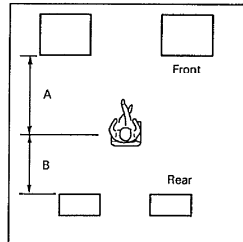

Example:  
 Delay time approx. 16ms when A=3m and B=4m  
 Delay time approx. 24ms when A=4m and B=3m

$$\text{Delay time (ms)} = 20\text{ms} + 3\text{ms} (A - B)$$

A : Distance of front speaker (m)

B : Distance of rear speaker (m)

- The delay time can be adjusted in the range from 16 to 30 ms.
- When one of the DELAY TIME keys is pressed, the delay time is displayed and varied in 2.0 ms steps per press the key.
- Once a delay time is set, it is automatically held in memory so the same delay time is displayed whenever Dolby Surround is switched ON later.



## ■ Operation of Dolby Surround playback

When playing a video software program carrying "DOLBY SURROUND" mark, use the following procedure to obtain similar Dolby Surround effect to movie theaters.

**1 Press the PRO-LOGIC key.**

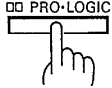

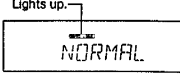

**2 Adjust the Dolby Surround input balance.**

① **Play the video software with the Dolby Surround mark.**

- Play the scene with a lot of dialogues in the video software to be watched.

② **Set the center mode to the C-OFF.**

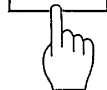

NORMAL → WIDE → PHANTOM

← C-OFF ←

Every time the key is pressed, the center mode is switched as shown above, and the name of the mode is displayed.

③ **Adjust the balance between the left and right inputs.**

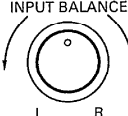

Adjust so that the dialogue sound from the front speakers is minimized.

④ **Stop playing the video software.**

**3 Select the center mode.**

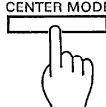

NORMAL → WIDE → PHANTOM

← C-OFF ←

DOLBY SURROUND

WIDE

The display returns to the input source display in about 5 seconds.

**PHANTOM**

- Use this mode when the center speaker is not used.
- Even without the center speaker, the signal is processed in a simulated manner to ensure proper center image positioning and provide the enjoyment of Dolby Surround.

**C-OFF**

- Turns the center speaker sound off.

**NORMAL**

- Use this mode with a center speaker of a compact size.
- This improves the sound positioning of medium and higher frequencies.
- Use this mode when the optional CS-7 center speaker is used.

**WIDE**

- Use this mode with a center speaker of a medium or larger size.
- This improves the sound positioning all over the frequency range.
- If you cannot identify whether your center speaker is of the medium or compact size, try both the NORMAL and WIDE mode and use the one that can provide better sound positioning.

**4 Play Dolby Surround video software.**

① **Play the video software recorded with Dolby Surround.**

② **Adjust the listening volume.**

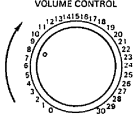

Adjust the overall volume.

**To return to normal stereo playback from Dolby Surround playback.**

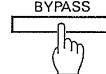

■ Storing Surround setup in memory

Remote control unit only

Setups for DOLBY 3 STEREO and PRO-LOGIC playback can be stored in memory and recalled by simple operation. Up to four setups can be stored in memory.

**1** Set a sound field for Dolby 3 Stereo or Pro Logic playback.

Set the playback condition referring to pages 23, 24 and 25. The setup contents which can be stored in memory are as follows.

DOLBY 3STEREO - CENTER MODE - CENTER LEVEL

DOLBY PRO-LOGIC - CENTER MODE - DELAY TIME - CENTER LEVEL - REAR LEVEL

**2** Press the SURROUND MEMORY key on the remote control unit.

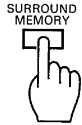

- The MEMORY indicator is displayed for 5 seconds; perform steps 3 and 4 in this period.

**3** Select a memory number.

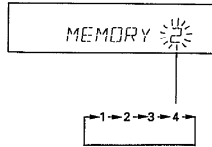
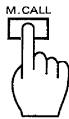

The displayed memory No. changes every time the M.CALL key on the remote control unit is pressed.

**4** Store the setup in memory.

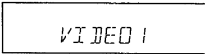

The input source display resumes.

Press again.

■ Recalling Surround setup from memory

Remote control unit only

Select the memory number.

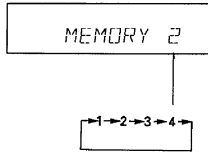

The displayed memory No. changes every time the M.CALL key on the remote control unit is pressed.

- The stored contents with the memory No. being displayed are represented.

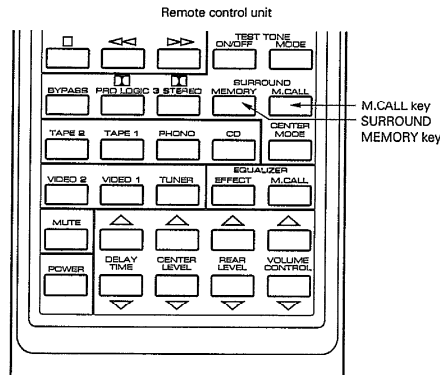

## Surround speakers

Surround rear speakers and center speaker are necessary for full enjoyment of the Dolby Surround effects.

**Surround rear speaker:** Enhances the feeling of presence in the listening room.

**Center speaker:** Clarifies the positioning of words in movies or acoustic image of musical instruments located on the center.

- Connect the optional KENWOOD Surround rear speakers and center speaker referring to page 6.

### Arrangement of Surround speakers

- Rear speakers can be placed with various arrangements according to the listening room size and its reverberation characteristics. The example shown in the illustration is a typical example among several arrangements which allow efficient enjoyment of Surround effects. In addition to it, other arrangements are also possible. Please install the rear speakers according to your individual taste as well as to the listening room.

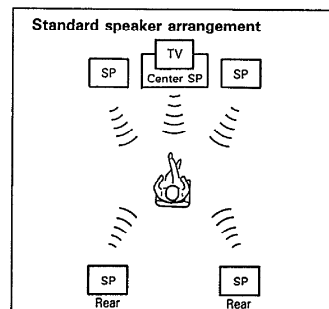

- The ideal location of the center speaker is on the same axis as the front of the TV screen. Please install the center speaker above, below or on the side of the TV set, for example, so that the best positioning or acoustic image can be obtained.

## Delay time

As shown in the example of illustration, the sound of piano played on the stage attains the ears of listener as a synthesis of the direct sound from piano, the indirect sounds which are reflected once or twice by the reflectors, ceiling and side and back walls, and the reverberation sounds which repeat infinite reflections until they fade out completely.

The indirect sounds always pass through longer routes compared to the direct sound. The delay between the direct and indirect sounds is called the DELAY TIME, and the level of the indirect or reverberated sounds is called the PRESENCE LEVEL. The indirect sounds accompanied with delay play a very important role in providing better sound effects and the feeling of presence of concert halls, etc. The acoustic field also varies depending on the speaker arrangement. It is recommended to try various delay time setting to obtain the best sound field possible.

Example of a concert hall

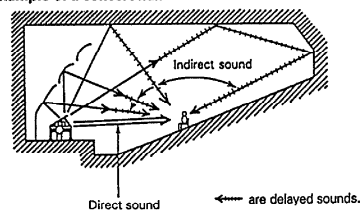

## In case of difficulty

What appears to be a malfunction may not always be serious. If your unit should not perform as expected, consult the table below to see if the problem can be corrected before seeking help from your dealer or service representative.

### Remote control unit

Symptom	Cause	Remedy
Remote control operation is not possible.	<ul style="list-style-type: none"> <li>● Batteries are exhausted.</li> <li>● The audio cords and the system control cords are not connected properly.</li> <li>● The remote control unit is too far away from the main system, controlling angle is too large, or there is an obstacle in between.</li> <li>● The source component to be operated does not contain the analog disk, tape(s) or CD.</li> <li>● An attempt is made to play a tape which is being recorded in the cassette deck.</li> </ul>	<ul style="list-style-type: none"> <li>● Replace with new batteries.</li> <li>● Connect properly referring to "System connections".</li> <li>● Operate the remote control unit within the controllable range.</li> <li>● Place an analog disk, tape(s) or CD in the source component to be played.</li> <li>● Wait until the recording is completed.</li> </ul>

### Amplifier section

Symptom	Cause	Remedy
Sound is not output.	<ul style="list-style-type: none"> <li>● The speaker cords are disconnected.</li> <li>● The VOLUME is set to the minimum position.</li> <li>● The MUTE key of the remote control unit is set to ON and the point indicator is blinking.</li> </ul>	<ul style="list-style-type: none"> <li>● Connect them properly referring to "System connections".</li> <li>● Adjust the volume to a proper level.</li> <li>● Press the MUTE key to OFF.</li> </ul>
No sound comes out, and "PROTECT" is shown on the display.	<ul style="list-style-type: none"> <li>● Speaker cords are short-circuited.</li> </ul>	<ul style="list-style-type: none"> <li>● Turn the power off, eliminate the short-circuiting, then turn on the power again.</li> </ul>
Sound is not output from one of the speakers.	<ul style="list-style-type: none"> <li>● The speaker cord is disconnected.</li> <li>● The BALANCE control is set to an extreme position.</li> </ul>	<ul style="list-style-type: none"> <li>● Connect it properly referring to "System connections".</li> <li>● Adjust the Left/Right balance.</li> </ul>
Sound is not output from the Surround rear speaker and/or center speaker, or the sound is very small.	<ul style="list-style-type: none"> <li>● The rear-speaker cords and/or center speaker cord are disconnected.</li> <li>● The Surround play mode has not been engaged.</li> <li>● The REAR LEVEL and/or CENTER LEVEL controls are set to the minimum level.</li> <li>● The SPEAKER IMPEDANCE SELECTOR on the rear panel is set to the SURROUND off side.</li> </ul>	<ul style="list-style-type: none"> <li>● Connect them properly referring to "System connections".</li> <li>● Set the Dolby Surround or 3 STEREO mode.</li> <li>● Adjust the REAR LEVEL and CENTER LEVEL controls.</li> <li>● Set the SPEAKER IMPEDANCE SELECTOR to the SURROUND ON side.</li> </ul>
A hum noise is generated when the PHONO input selector key is pressed.	<ul style="list-style-type: none"> <li>● The audio cord from the turntable is not inserted securely into the PHONO jacks.</li> <li>● The turntable is not grounded.</li> </ul>	<ul style="list-style-type: none"> <li>● Insert the audio cord plugs securely into the PHONO jacks.</li> <li>● Connect the grounding wire to the GND terminal on the rear panel.</li> </ul>

## Tuner section

Symptom	Cause	Remedy
Radio stations cannot be received.	<ul style="list-style-type: none"><li>● No antenna is connected.</li><li>● The broadcast band is not set properly.</li><li>● The frequency of the desired station is not tuned.</li></ul>	<ul style="list-style-type: none"><li>● Connect an antenna.</li><li>● Set the broadcast band properly.</li><li>● Tune the frequency of the desired station.</li></ul>
A station which was preset cannot be received by pressing the corresponding numeric key.	<ul style="list-style-type: none"><li>● The preset station belongs to a frequency that cannot be received.</li><li>● The preset memory was cleared because the power cord had been unplugged for a long period of time.</li></ul>	<ul style="list-style-type: none"><li>● Preset a station with a receivable frequency.</li><li>● Preset the station again.</li></ul>
Interference.	<ul style="list-style-type: none"><li>● Noise due to ignition noise of an automobile.</li><li>● Noise due to an influence from an electric appliance.</li><li>● Noise due to a nearby TV set.</li></ul>	<ul style="list-style-type: none"><li>● Install the outdoor antenna apart from the road.</li><li>● Turn off the power of the appliance.</li><li>● Install the system more apart from the TV set.</li></ul>

### Notes:

1. This system is microprocessor-controlled, so malfunction may occur due to external noise or interference noise. In such a case, unplug the power cord, plug it and turn power on again.  
If the trouble still persists, unplug the power cord and connect the power cord again while pressing the TUNER key of the input selectors.
2. Do not use contact cleaners because it could cause a malfunction. Be specially careful against contact cleaners containing oil, for they may deform the plastic components.

Manufactured under license from Dolby Laboratories Licensing Corporation. Additionally licensed under one or more of the following patents: U.S. numbers 3,632,886, 3,746,792 and 3,959,590; Canadian numbers 1,004,603 and 1,037,877.  
"Dolby" and the double-D symbol  are trademarks of Dolby Laboratories Licensing Corporation.

### For the U.S.A.

#### FCC WARNING:

This equipment may generate or use radio frequency energy. Changes or modifications to this equipment may cause harmful interference unless the modifications are expressly approved in the instruction manual. The user could lose the authority to operate this equipment if an unauthorized change or modification is made.



**(For Europe)**

**Audio section**

**Rated power output at the STEREO operation**

(IEC) from 63Hz to 12,500 Hz,  
0.7% T.H.D. at 8  $\Omega$  ..... 110W + 110W  
(DIN) 1,000Hz at 8  $\Omega$  ..... 120W + 120W  
at 4  $\Omega$  ..... 100W + 100W

**Power output at the Surround operation**

Front (1kHz, 0.9% T.H.D. at 8  $\Omega$ ) ..... 65W + 65W  
Center (1kHz, 0.9% T.H.D. at 8  $\Omega$ ) ..... 65W  
Rear (1kHz, 0.9% T.H.D. at 8  $\Omega$ ) ..... 15W + 15W

Total harmonic distortion (1kHz, 8  $\Omega$ ) ..... 0.03% at 50W

Frequency response  
CD ..... 10Hz – 50kHz +0dB  
-3dB

**Signal to noise ratio (IHF-A)**

PHONO (MM) ..... 78dB for 5mV input  
CD, TAPE, VIDEO ..... 98dB for 200mV input

**Signal to noise ratio (DIN weighted at 50mW output)**

PHONO (MM) ..... 57dB  
CD, TAPE, VIDEO ..... 58dB

**Input sensitivity/impedance**

PHONO (MM) ..... 2.5 mV/47k  $\Omega$   
CD, TAPE, VIDEO ..... 200mV/47k  $\Omega$

**Tone controls**

BASS .....  $\pm 10$ dB (at 100Hz)  
TREBLE .....  $\pm 10$ dB (at 10kHz)

**Video section**

VIDEO Inputs/outputs ..... 1 Vp - p, 75  $\Omega$  unbalanced

**FM Tuner section**

Tuning frequency range ..... 87.5MHz–108MHz  
Antenna impedance ..... 75  $\Omega$  unbalanced

**Sensitivity (DIN)**

MONO ..... 1.2  $\mu$ V  
STEREO ..... 40  $\mu$ V

**Total harmonic distortion (DIN at 1kHz, 65.2dBf input)**

MONO ..... 0.15%  
STEREO ..... 0.3%

**Signal to noise ratio (DIN weighted at 1kHz, 65.2dBf input)**

MONO ..... 66dB  
STEREO ..... 61dB

Selectivity (DIN  $\pm 300$ kHz) ..... 53dB

Stereo separation (DIN) ..... 45dB (at 1 kHz)

Sub carrier suppression ratio (DIN) ..... 50dB (at 19kHz)  
60dB (at 38kHz)

Frequency response ..... 30Hz – 15 kHz +0.5dB  
-2.0dB

**AM Tuner section**

Tuning frequency range ..... 531kHz ~ 1,602kHz  
Usable sensitivity ..... 12 $\mu$ V/(400  $\mu$ V/m)

Total harmonic distortion ..... 0.5%

Signal to noise ratio ..... 50dB

Selectivity ..... 23dB

**General**

Power consumption ..... 230W (IEC)

Dimensions ..... 440 (W) x 147 (H) x 398 (D) mm

Weight (net) ..... 10.9kg

AC outlet ..... switched x 1 200W max.

**Note:**

KENWOOD follows a policy of continuous advancement in development. For this reason specifications may be changed without notice.

**Strömbrytarens POWER beredskapsläge**

Indikatorn STAND BY tänds efter nätkabelns anslutning till ett vägguttag, oavsett strömbrytarens POWER till/frånslag. Detta anger att en liten mängd ström leds till komponenten som stöd för minnesnehållret och också för att skydda de installationer, som lagrats i minnet, för timerstyrda funktioner mot radering. Detta läge kallas för beredskapsläget. Strömbrytaren på fjärrkontrollen kan användas för att slå på och av strömmen så länge indikatorn STAND BY lyser.

**Virtanäppäimen (POWER) valmiustila (STAND BY)**

Kun laitteen verkkajohto on liitetty pistorasiaan, valmiustilan merkivalo syytty riippumatta virtanäppäimen (POWER) asennosta (ON/OFF). Merkivalo osoittaa, että laitteessa on hieman virtaa muistin sisältöjen ja ajastintoiminnon ylläpitoa varten. Tätä tilaa kutsutaan valmiustilaksi. Kun valmiustilan merkivalo (STAND BY) palaa, laitteen virta voidaan kytkeä ja katkaista kaukosäätimellä.

**Afbrydertastens (POWER) STAND BY funktion**

Når apparatets strømledning er tilsluttet en stikkontakt, lyser STAND BY indikatoren, uanset om der er tændt ved afbryderen på apparatet eller ej. Det angiver, at apparatet bliver forsynet med en ganske lille mængde strøm til opret-holdelse af hukommelsens indhold og til timeren. Denne funktion kaldes STAND BY. Når STAND BY indikatoren er tændt, kan strømmen til apparatet slås til og fra med fjernsty-ringsenheden.

**PÅ/AV-knappens Stand-by funksjon**

Når strømledningen til dette anlegget er satt i en vekselstrømskontakt, vil STAND-BY indikatorlampen lyse enten PÅ/AV-knappen er på- eller avslått. Dette betyr at en viss mengde strøm tilføres anlegget slik at innholdet i minnet samt timer-funksjonen ikke går tapt. Denne funksjonen kalles Stand-by. Når indikatorlampen for STAND-BY er tent, kan strømmen slås PÅ/AV fra fjernkontrollen.

---

KENWOOD

---

---